

پودمان ۵

کسب اطلاعات فنی



وَمِنْ آيَاتِهِ خَلْقَ السَّمَاوَاتِ وَالْأَرْضِ وَاخْتِلَافُ أَلْسِنَتِكُمْ وَاللُّوَانِكُمْ إِنَّ فِي ذَلِكَ لَآيَاتٍ لِّلْعَالَمِينَ

سوره روم - آیه ۲۲

و از نشانه‌های او (قدرت خداوند) آفرینش آسمان‌ها و زمین و تفاوت زبان‌ها و رنگ‌های شماست. به درستی که در آنها نشانه‌هایی برای دانشمندان وجود دارد.

تسلط به زبان انگلیسی در دنیای امروز به ویژه در حوزه‌های تخصصی از جمله ماشین‌های کشاورزی، نیازی غیرقابل انکار است و هنرجوی این رشته باید بتواند مفهوم عبارات تخصصی فراگیر را به خوبی درک کند. بدیهی است برای کسب و تبادل اطلاعات در زمینه خرید، فروش، سرویس و نگهداری بسیاری از ماشین‌ها و ادوات کشاورزی، آشنایی با زبان تخصصی این رشته از اهمیت ویژه‌ای برخوردار است.

این واحد یادگیری در ۵ درس تنظیم شده و هر درس شامل دو بخش خواندن و فعالیت‌های یادگیری هدف‌دار می‌باشد. پیش از هر درس، واژه‌های کلیدی معرفی شده است تا در یک نگاه، دید کلی از محتوای درس فراهم شود.

واحد یادگیری ۱

کسب اطلاعات فنی

درس اول: ماشین‌های کشاورزی

به تلفظ کلمات با دقت گوش داده و تکرار کنید.

کلمت
کلیدی



Agricultural machinery	Fertilizer spreader	Pest	Self-propelled
Baler	Fertilizing	Planting	Slurry tank
Broadcaster	Grain Drill	Plough	Sowing
Chisel Plow	Hand tools	Potatoes harvester	Sprayer
Combinata	Harrow	Primary tillage	Trailers
Combine harvester	Harvesting	Roller	Trans Planters
Cultivator	Hay forage Harvester	Rotary Plow	Tillage
Disking	Land Leveller	Rotary tiller	Tooth Harrow
Disk Harrow	Moldboard Plow	Row Crop Planter	Towed behind
Disk Plow	Mounted	Seeder	Weed
Farm implements	Mower	Secondary tillage	

الف - خواندن و درک مطلب

Agricultural machinery is a key factor in mechanized farming and modern agriculture. Agricultural machinery is any kind of machinery used in farming or other agriculture applications. There are many types of such equipment, from hand tools and power tools to tractors and the countless kinds of farm implements that they tow or operate. The well-known example of this kind is the tractor.



کسب اطلاعات فنی

A tractor is an agricultural/engineering vehicle. Agricultural implements may be towed behind or mounted on the tractor and a tractor may also provide a source of power if the implement is mechanized. A farm tractor is used for pulling or pushing agricultural machinery or trailers, for ploughing, tilling, disking, harrowing, planting, harvesting and other similar tasks.

There are different types of tasks, such as soil cultivation (soil tillage), planting (sowing), etc. For these, there are also different machines or equipment. Some of them are listed below.

Soil Tillage Machinery (Soil Cultivation Machinery): Moldboard Plows, Disk Plows, Chisel Plows and Rotary Plows are used for primary tillage. Disk Harrows, Tooth Harrows, Rollers and Land Leveller are used for secondary tillage.

Planting (Sowing) Machinery: Broadcaster, Seeders, Grain Drills, Row Crop Planters, Trans Planters and Combinata.

Plant Protection Machinery (Fertilizing & Pest and Weed Control Machinery): fertilizer spreader, slurry tank, sprayer

Harvesting Machinery: combine harvester, potatoes harvester, hay forage harvester, baler and mower are some of important harvester's in Iran.

Iran produces agricultural machinery such as tractor, combine and other related equipment by more than 300 manufacturers.

Did you know?



ب- فعالیت های کلاسی

برداشت خود از متن بالا را در چند سطر به فارسی بنویسید.

.....

.....

.....

فعالیت کلاسی ۱



نام مرتبط به هر ماشین را در مقابل تصویر آن بنویسید.
tractor sprayer blower, broadcast spreader, chisel plough, sprayer, drum mower, mouldboard plough, cube baler, potato harvester

فعالیت کلاسی ۲



Machinery/Equipment	Names	Machinery/Equipment	Names
			
			
			
			

نام هر کدام از ماشین‌های ذکر شده را در مقابل گروه مشخص شده بنویسید.
 Moldboard Plows, Rollers, Land Leveller, Disk Plows, Disk Harrows, Chisel Plows, Rotary Plows , Tooth Harrows.

فعالیت
 کلاسی ۳

نام گروه	نام ماشین‌ها
primary tillage	
secondary tillage	



در محل تعیین شده در متن، حرف مربوط به تصویر مرتبط را بنویسید.



is a machine that combines the tasks of harvesting, threshing, and cleaning grain crops. (.....)



sows the seeds for crops in a ploughed field. (.....)



used for pulling or pushing agricultural machinery. (.....)



soil in preparation for sowing seed or planting. (.....)

درس دوم: ساختمان موتور دیزل

به تلفظ کلمات با دقت گوش داده و تکرار کنید.

کلمت
کلیدی



Camshaft	Diesel	Spark plug	Main bearing
Compression	Engine	Sprinkler	Timing drives
Connecting rod	Exhaust	Stroke	Transmission
Crankshaft	Flywheel	Four-stroke cycle	Two-stroke cycle
Cylinder	Piston	Injection nozzle	Valve
Cylinder block	Piston ring	Intake	
Cylinder head	Power	Internal combustion	

الف - خواندن و درک مطلب

Agricultural machinery uses mostly diesel internal combustion engines, as most agricultural operations are carried out in motion, for tractors, harvesters, and self-propelled sprinklers, among others. In general, these engines are divided into two categories: two-stroke cycle and four-stroke cycle engines.

In tractors and combine harvesters, the diesel engines are commonly four-stroke cycle type. A four-stroke cycle engine completes four strokes in one operating cycle, including: intake, compression, power, and exhaust strokes.

All four-stroke cycle engines have common parts regardless of the type. Some of them are listed below.

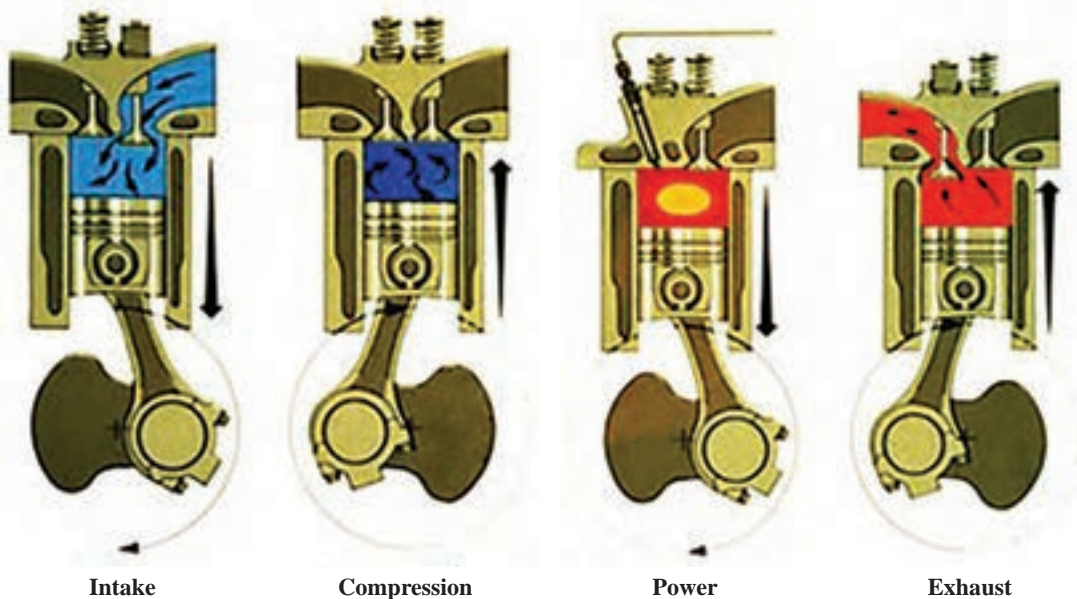

All four-stroke cycle engines have common parts regardless of the type. Some of them are listed below.

- Cylinder block is the main house of the engine and supports the other main parts.
- Crankshaft receives the force from the pistons and transmits it as rotary driving power.

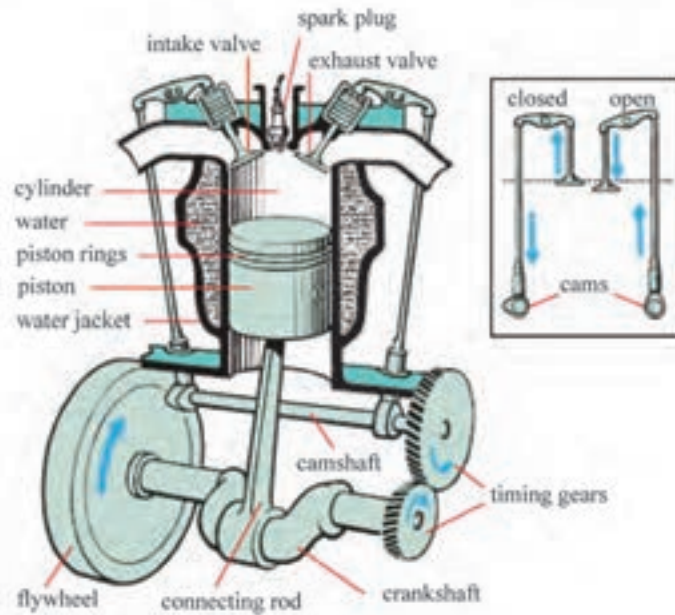

- Connecting rod transmits the reciprocating motion of the piston into rotary motion of the crankshaft.
- Piston moves up and down in the cylinder by the force of combustion.
- Piston rings seal the compression in the combustion chamber and also help to transfer heat.
- Cylinder head is at the top of the engine and houses the valves and the intake and exhaust passages.
- Valves open and close to let fuel in and exhaust gases out of each cylinder.
- Camshaft rotating in the engine block opens valves by cam action.
- Cylinder is a hollow tube in which the piston works. This may be cast into the cylinder block or made of liner and sleeve.
- Main bearings support the crankshaft in the cylinder block.
- Flywheel attaches to the crankshaft and gives it momentum to return the piston(s) to the top of the cylinder(s) after each downward thrust.
- Timing drives (timing gears) link the crankshaft, camshaft, and other key parts together to assure that each is doing its job at the right time.
- Injection nozzle (Fuel injector) atomizes and sprays fuel into the cylinder.

Although there is no spark plug of the diesel engine, it is a key part in the petrol engine (in US: gasoline engine).

Note



Never open the radiator cap when the engine is hot. Always wait for the engine to cool down.

Remember



In Tabriz, there is the largest manufacturer of diesel engines in the country with the services and equipment necessary to design and manufacture three-, four- and six-cylinder engines for various applications, such as agriculture, automobile, industrial, road machinery, etc.

Did you know?



ب- فعالیت های کلاسی

برداشت خود از متن فوق را در چند سطر به فارسی بنویسید.

.....

.....

.....

.....

.....

فعالیت
کلاسی ۱



جواب مناسب هر سؤال را با علامت (x) مشخص کنید.

1_ What does the intake valve do?

- a) Releases excess fuel from the combustion chamber
- b) Supplies the combustion chamber with air
- c) Gets rid of the exhaust
- d) Keeps the engine cool by supplying water

2_ What's a piston?

- a) Cylindrical piece of metal that moves up and down using the energy supplied by the combustion process
- b) Metal wire that carries an electric charge for the spark plug
- c) Valve that transfers fuel to the combustion chamber
- d) Tube that supplies water to the engine's cooling system

3_ What is the fourth and final stage of a four-stroke engine called?

- a) Exhaust
- b) Compression
- c) Intake
- d) Combustion

4_ What are the purpose of piston rings?

- a) Keeps a tight seal on the cylinders
- b) Small pieces of metal that connects the parts of the crankshaft together
- c) Keeps the oil from drying out
- d) Kdeeps a tight seal on the piston heads so fuel and air doesn't leak into the sump

5 _ What connects the piston and crankshaft together?

- a) Cylinder
- b) Camshaft
- c) Connecting rod
- d) Piston rings





با توجه به شکل اعداد مناسب را در مقابل کلمات مرتبط بنویسید.

Piston	
Intake valve	
Connecting rod	
Crankshaft	
Oil	
Exhaust valve	
Cylinder	
Cylinder head	
Cylinder block	
Fuel injector	
Crankcase	
(Oil pan (Sump	
Cooling water	
Piston pin (in US: Gudgeon pin, in UK: Wrist pin)	

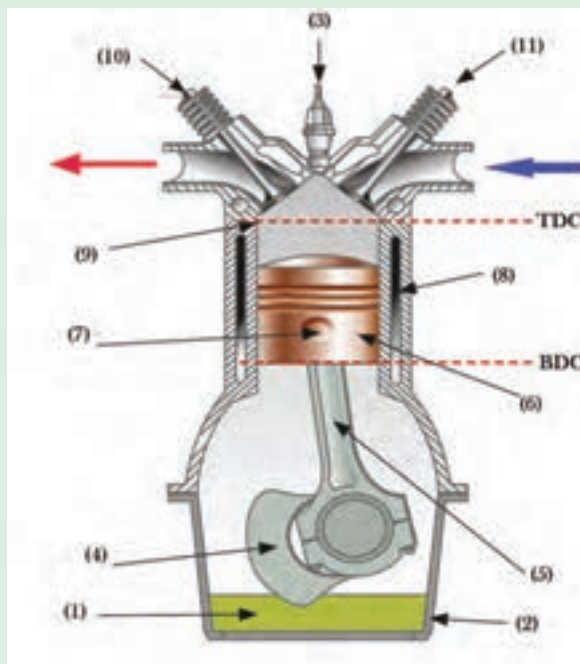

TDC = Top dead centre, BDC = Bottom dead centre

درس سوم: راهنمای انتخاب تراکتور

به تلفظ کلمات با دقت گوش داده و تکرار کنید.

Accessories	Horsepower	Regular maintenance
After-sales service	Manufacture	Specifications
Agency	Model	Technical specifications
Brand	Operator	Transmission
Four-wheel drive (4WD)	Product catalogue	Two-wheel drive
Front-wheel drive (FWD)	Purchase	Warranty
Guarantee	Rear-wheel drive (RWD)	



الف - خواندن و درک مطلب

Choosing agricultural machinery has been a problem for farm operators and unrelated engineers ever since agriculture became mechanized. The wide variety of sizes, types and brands of machinery created an infinite number of combinations, and the complexity of the relationships which affect machinery costs and performance make the decision difficult. Knowing what to look for when buying any machinery can save time and money. The tractor is the most frequently used power source on farms throughout the year, unlike other agricultural machinery which have specific and occasional use. For that reason, some of the most important factors to choose a tractor are listed in the following questions.

<ul style="list-style-type: none"> ● How to choose a machinery size? ● What specifications to look for? ● Which brand is the best? ● How much horsepower is needed? ● What type of tractor is required? ● What about the model? ● What type of transmission do you want? ● Two-wheel drive (2WD), Four-wheel drive (4WD), front-wheel drive (FWD) or rear-wheel drive (RWD)? ● What equipment will you need? ● What about regular maintenance? ● What about after-sales service? ● What investment can you make? 	
--	---

Keeping the related factors in mind can help guarantee customers/operators end up with the best tractor for the specific needs.

To find answers to the above questions, you can refer to the website of the manufacturers of agricultural machinery (or the products catalogues) and compare with what you need. The websites (or the products catalogues) of relevant companies usually provide good information including the types of products, after-sales services, warranties, agencies,

catalogues, parts, accessories, technical specifications of the machines and how to purchase them. In the following picture, a website of the machinery company is presented, which shows the items of “Products” option along with the figure of a highlighted model of “Tractors” option.

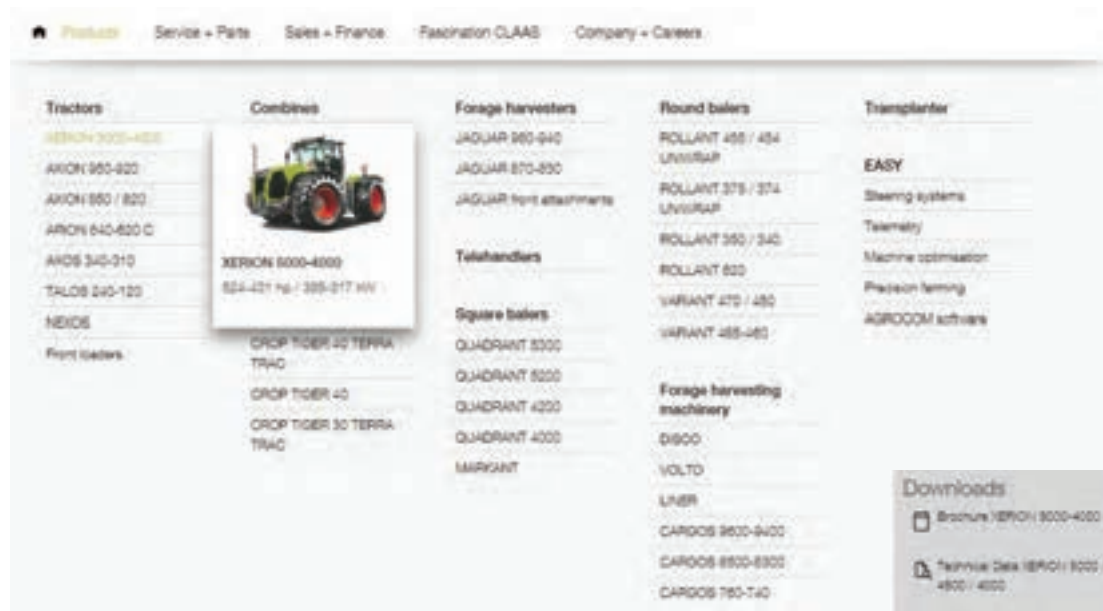

Never buy a tractor based on HP, it is very deceiving. And never buy any machinery without seeing it in person.

Remember



More than 70% of Iran’s agricultural machinery are nationally manufactured and the rest are imported. In Iran, an agricultural mechanization coefficient of 105 horsepower per hectare is reported.

Did you know?



ب- فعالیت های کلاسی

برداشت خود از متن بالا را در چند سطر به فارسی بنویسید.

.....

.....

.....

فعالیت کلاسی ۱



با مراجعه به کاتالوگ ارائه شده، مشخصات فنی تراکتور را در جدول زیر، وارد کرده و جدول را تکمیل کنید.

فعالیت
کلاسی ۲



ENGINE		PERFORMANCE	
Make/Type	/MN325D	Rated engine power@2250 rev/min	47hp
Number of cylinders	3	MAX engine Torque@1250 rev/min	173Nm
Injection	Direct Distributor Type	Max P.T.O power@540 rev/min	37.7hp
Bore	91.4 mm	WHEELS AND TYRES	
Stroke	127mm	Front	6.16
Capacity	2.5 litre	Rear	12.4-28
Compression Ratio	18.5:1	CAPACITIES	
Starting Aid	Thermostat	Fuel tank	50 litre
Cooling	Water	Hydraulic system	31 litre
Air cleaner	Dry	Engine sump	5.7 litre
Fuel filter	Dual	Cooling system	10.2 litre
Exhaust	Horizontal	WEIGHT AND DIMENSION	
ELECTRICS		Weight	
Voltage	12V. Negative earth	- Rear	740Kg
Battery	70AH	- Front	1490Kg
Starter	1.8 KW	- Total	2230Kg
Alternation	45Amp	Overall lengths	3210 mm
Lights	Head lights	Width	1800 mm
	Side lights	height	2300 mm
	Brake lights	POWER TAKE OFF	
	Direction indicator	Type	540 rev/min
	Rear plough lamp	Shaft diameter	live at 1789
Other	Horn. 7 pin trailer socket	No. of splines	rev/min
CLUTCH			engine
Type	Dual clutch		35mm
Diameter	305 mm		6
TRACK ADJUSTMENT		STEERING	
Front	1220mm-1930mm	Type	Hydrostatic
Rear- preesed	1320mm-1930mm	TRANSMISSION	
HYDRAULICS		Type	Slide
Max oil flow	16.7 litre/min	10Speed	8forward, 2 reverse
Max pressure	173 bar	HYDRAULICS	

Rated engine power	Height
Max P.T.O power	Starting aid
Number of cylinders	Fuel tank capacity
Cooling	Front track adjustment
Air cleaner	Wheels and tyres sizes
Compression ratio	Three point linkage

P.T.O = Power take-off, RPM=rev/min= Revolutions per minute.

Note



درس چهارم: اصول ایمنی در ماشین های کشاورزی

به تلفظ کلمات با دقت گوش داده و تکرار کنید.

کلمت
کلیدی



Assistance	Faulty maintenance	Manuals	Safety consciousness
Attention	Hazard	Minor injury	Safety instructions
Accident	Instruction	Moderate injury	Safety signs
Caution	Injury	Operator's manuals	Serious injury
Cure	Improper	Prevention	Servicing
Dangerous	Machinery dealer	Properly	Warning
Danger	Manipulation	Regulations	linkages

الف - خواندن و درک مطلب

All farm machinery can be dangerous if are not used properly. Each part of the machinery can also be dangerous, if there is improper manipulation or faulty maintenance with the machine. Thus, the operators must ensure they are safety conscious at all times.

In agriculture, a machine operator is responsible for operating and maintaining complicated machinery and making sure it functions properly. For this, a basic knowledge of manuals, regulations, safety instructions, safety signs and signals is essential. In addition to the above, reading the related booklets of machinery is valuable and important.

Follow Safety Instructions

- Carefully read all safety messages in the manual and on your machinery safety sings.
- Do not let anyone operate without instruction.
- Learn how to operate the machinery and how to use controls properly.
- Keep your machinery in proper working condition.
- If you do not understand any section of the manual and need assistance, contact your machinery dealer or agency of the company.



Safety Signs

Agricultural machinery and equipment should be provided with safety signs to alert an operator and others of the risk of personal injury in normal operations and servicing. These safety signs are visible on most agricultural machinery and in operator's manuals. Safety signs are classified according to the relative seriousness of the hazard situation by use signal words. The words CAUTION, WARNING, and DANGER, in that order indicate degrees of hazards. These signal words alert viewers to the existence and relative seriousness of a hazard. There are other words such as, IMPORTANT, ATTENTION, and NOTICE for instructional signs.

CAUTION

This word indicates a potentially hazardous situation which, if not avoided, may result in minor or moderate injury.

WARNING

The word indicates a potentially hazardous situation which, if not avoided, could result in death or serious injury.

DANGER

This word indicates an imminently hazardous situation which, if not avoided, will result in death or serious injury.



Never forget that “prevention is better than cure”.

Remember



Although the number of farm accidents is globally remarkable, there is no clear data available on this topic for Iran.

Did you know?



ب- فعالیت های کلاسی

برداشت خود را از متن فوق در چند سطر به فارسی بنویسید.

.....

.....

.....

فعالیت
کلاسی ۱



حرف مربوط به هر تصویر ایمنی را در مقابل متن مربوط به آن بنویسید.

A	B	C	D	E

فعالیت
کلاسی ۲



- | | |
|--|--|
| 1_ High pressure fluid-injection into body | |
| 2_ Falling into machinery-Auger | |
| 3_ Severing of toes or fingers-Rotary mower blade | |
| 4_ Severing of fingers or hand-Engine fan | |
| 5_ Riding on this machine is allowed only on a passenger seat. | |

متن مناسب تصویر ارائه شده را با علامت (x) مشخص کنید.

- A. Shut off engine and remove key before performing maintenance or repair.
- B. Do not ride on machine except in supplied seat.
- C. Keep a safe distance from the machine.
- D. Avoid fluid escaping under pressure. Consult technical manual for service procedures.



فعالیت
کلاسی ۳



از بین کلمات داده شده، کلمه مناسب در جای خالی جملات قرار دهید.

proper, properly, machinery dealer, prevention, faulty maintenance, operators, dangerous, anyone, Learn, improper manipulation, all over the world, agency, exception, safety signs, manual

- a) All farm machinery can beif are not used.....
- b) how to operate the machine and how to use controls properly.
- c) Do not let operate without instruction.
- d) Keep your machinery in working condition.
- e) Never forget that “.....is better than cure”.
- f) If you do not understand any section of the manual and need assistance, contact your orof the company.

فعالیت
کلاسی ۴



گزینه یا گزینه‌های صحیح را با علامت (x) مشخص کنید.

- 1_ How can you prevent injury while working on farm machinery?
- a) Do not work under a raised loader arm or bucket.
 - b) Use your hands to feel inside the machinery to find jams.
 - c) Wear provided personal protective equipment.
 - d) Do not perform maintenance or adjustments until both the driveline and machinery have completely stopped moving.

فعالیت
کلاسی ۵



2_ Which of the following should you do before operating any machinery?

- a) Be properly trained in equipment use.
- b) Ensure machine guarding is in place.
- c) Read and follow all instructions in the operator's manual pertaining to the machinery.
- d) Perform a pre-operational service check before operating machinery and correct any identified problems before starting the machinery.

3_ You can become entangled in moving machinery parts by:

- a) Wearing jewellery that hangs down loosely.
- b) Wearing loose clothing with drawstrings or shawl.
- c) Wearing long hair loose, and not tied back or secured properly.
- d) Putting hands or body parts into machinery to remove jammed items.

قسمتی از کتابچه راهنمای یک تراکتور در شکل زیر آورده شده است. متن آن را ترجمه کنید.

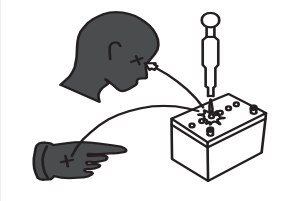
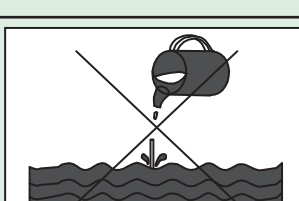
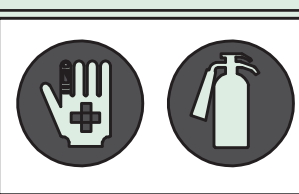
	<p>VENTILATE WORK AREA If the engine must be running to do some work, make sure the area is well ventilated. Never run the engine in a closed area. The exhaust gas contains poisonous carbon monoxide.</p>
	<p>PREVENT ACID BURNS Sulfuric acid in battery electrolyte is poisonous. It is strong enough to burn skin, clothing and cause blindness if splashed into eyes. Keep electrolyte away from eyes, hands and clothing. If you spill electrolyte on yourself, flush with water, and get medical attention immediately.</p>
	<p>DISPOSE OF FLUIDS PROPERLY Do not pour fluids into the ground. Down a drain, or into a stream, pond, or lake. Observe relevant environmental protection regulations when disposing of oil, fuel, coolant, electrolyte and other harmful waste.</p>
	<p>PREPARE FOR EMERGENCIES Keep a first aid kit and fire extinguisher handy at all times. Keep emergency numbers for doctors, ambulance service, hospital and fire department near your telephone.</p>

درس پنجم: کسب اطلاعات از کتابچه راهنمای ماشین

به تلفظ کلمات با دقت گوش داده و تکرار کنید.

کلمت
کلیدی



Air cleaner	Clutch	Lubricant	Replacing
Axle	Cooling system	Machine capacity	Seal
Bearing	Electrical system	Machine element	Servicing
Belt	Frame	Maintenance	Steering
Brake	Fuel system	Manual	Technical data
Cam and follower	Gear trains	Operator instruction book	Transmission
Chain	Hydraulic	Repair	User's manual
Checking	Linkage	Repair instruction book	

الف - خواندن و درک مطلب

The manuals provided by manufacturers which cover the operation, servicing, maintenance and repair of their products.

Operator instruction book: This series shows you much more than how to safely operate equipment. These books explain machine capacities and adjustments, how to improve machine performance, how to eliminate unnecessary field operations, and how to service agriculture equipment.

The service includes checking, adjusting and replacing parts in specified time periods. For example, a tractor's services include checking, adjusting and replacing components of fuel system and air cleaner, cooling system, electrical system, transmission and hydraulics, steering, clutch and brakes.

Repair instruction book: These books concentrate on mechanical technology, bringing together technical information and supporting instructional aids that will help you become more proficient in understanding, repairing, and maintaining agricultural equipment and contains information such as technical data and other information needed for repair or replacement of mechanical elements.

Machine element refers to an elementary component of a machine such as frame members, bearings, axles, seals, lubricants, gear trains, belt or chain drives, linkages, cam and follower systems, including brakes and clutches.

ب- فعالیت های کلاسی

برداشت خود را از متن فوق در چند سطر به فارسی بنویسید.

فعالیت
کلاسی ۱



فعالیت
کلاسی ۲



شکل زیر قسمتی از کتابچه راهنمای تعمیرات یک دروگر استوانه‌ای را نشان می‌دهد. با توجه شکل به سؤالات زیر پاسخ دهید.

- ۱- اندازه مهره بزرگ چرخ تسمه (۳) چقدر است؟
- ۲- اگر بخواهیم این مهره را از شرکت سازنده خریداری کنیم، شماره فنی آن چند است؟
- ۳- این مهره بر اساس چه شماره‌ای از استاندارد دین ساخته شده است؟
- ۴- قطعه گردگیر با چه شماره‌ای مشخص شده است؟
- ۵- واشر تنظیم در چه اندازه‌هایی ارائه شده است؟

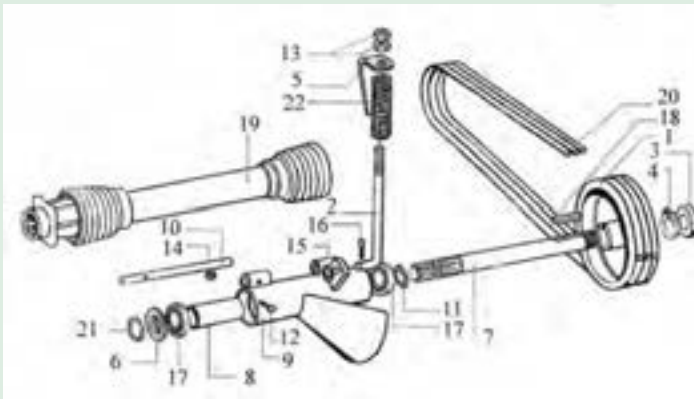

NO.	Part No.	Description	Dim.	QTY.	NO.
1	P0560004	V-belt pulley		1	
2	S1605012	Tension bolt M16*2		1	
3	S1647902	Hex nut M30*2*12	934	1	
4	S1720066	Tab washer 30.5*67*1.5		1	
5	S0160154	Spring tension indicator		1	
6	S0160165	Dust shield		1	
7	S0280070	Main drive shaft		1	
8	S0400091	Spacing tube		1	
9	S0120106	Pto input bearing housing		1	
10	S0280072	Pin		1	
11	S1760054	Shim 35*50*0.1		N.B	
-	S1760055	Shim 35*50*0.3		N.B	
-	S1760056	Shim 35*50*0.5		N.B	
-	S1760057	Shim 35*50*1		N.B	
12	S1601009	Hex bolt M6*1*50-8.8	933	1	
13	S1645002	Hex nut M16*2-8	934	2	
14	S1641001	Hex nut M6*1-8	934	1	
15	S1720067	Plain washer 14		1	
16	S1960012	Cotter pin 4*30	94	1	
17	S0960017	Ball bearing 6207 2RS	625	2	
18	S1920012	Key A8*7*50	6885	1	
19	A0001111	Pto drive shaft		1	
20	E1160002	V-belt B118		3	
21	S1840014	Circlip A35	471	1	
22	S0760010	Pressure spring		1	
23	S1440001	Grease nipple 8*1*100	71412	1	

نمودار زیر، سرویس‌های دوره‌ای یک تراکتور را نشان می‌دهد. با توجه به نمودار به سؤالات زیر پاسخ دهید.

- ۱- کدام یک از سرویس‌های سیستم خنک کننده نیست؟
- ۲- سرویس‌های سیستم هیدرولیک کدام‌اند؟ زیر آنها خط بکشید.
- ۳- سرویس‌های ۱۰ ساعته این تراکتور را مشخص کنید.

Carry out operation below when tachometer reads.....	۱۰	۱۰۰	۲۵۰	۵۰۰	۷۵۰	۱۰۰۰
GREASING	●	●	●	●	●	●
ENGINE						
Check the engine oil level and replenish if necessary	●	●	●	●	●	●
Change the engine oil			●	●	●	●
Change the engine oil filter			●	●	●	●
Check the tappets and adjust if necessary				*		*
Clean the engine breather pipe				*		*
FUEL SYSTEM AND CLEANER						
Inspect the fuel filter glass bowl and drain off any water	●	●	●	●	●	●
Change the fuel filter element				●		●
Service the injectors				*		*
Drain, Clean and refill the fuel tank						*
Check the dry air cleaner hoses and unloader valve	●	●	●	●	●	●
Replace the dry air cleaner elements						●
Check the level of oil in the oil bath air cleaner	●	●	●	●	●	●
Service the oil bath air cleaner			●	●	●	●
COOLING SYSTEM						
Check the radiator coolant level and replenish if necessary	●	●	●	●	●	●
Clean the radiator fins			●	●	●	●

Carry out operation below when tachometer reads.....	10	100	250	500	750	1000
Drain, flush and refill the cooling system				●		●
ELECTRICAL SYSTEM						
Check the battery electrolyte level and replenish if necessary		●	●	●	●	●
Wipe the battery top and smear the terminals with petroleum jelly		●		●	●	●
Check the alternator/fan belt tension and adjust if necessary	●	●	●	●	●	●
Examine the alternator						*
STEERING						
Check the power steering oil level and replenish if necessary		●	●	●	●	●
Check the steering box oil level				●		●
Change the power steering pump filter element				●		●
Check the front wheel alignment and adjust if necessary				*		*
TRANSMISSION AND HYDRAULICS						
Check the transmission oil level and replenish if necessary		●	●	●	●	●
Change the hydraulic oil				●		●
Change the transmission oil filter element			●	●	●	●
CLUTCH AND BRAKES						
Check the clutch pedal free travel and adjust if necessary		●	●	●	●	●
Check the live p.t.o clutch setting and adjust if necessary		*	*	*	*	*
Check the brakes and adjust if necessary		●	●	●	●	●
MISCELLANEOUS						
Check the torque of the wheel nuts and tighten if necessary		●	●	●	●	●
Check the tyre pressures and adjust if necessary	●	●	●	●	●	●

جدول ارزشیابی پودمان

نمره	شاخص تحقق	نتایج مورد انتظار	استاندارد عملکرد (کیفیت)	تکالیف عملکردی (واحد‌های یادگیری)	عنوان پودمان
۳	درک متون تخصصی انگلیسی و توانایی استخراج موارد ایمنی، زیست محیطی و مشخصات فنی ماشین‌های کشاورزی و ویژگی‌های اجزای آنها از کتابچه راهنما یا سایت اینترنتی شرکت‌های سازنده - مقایسه مشخصات فنی انواع یک ماشین با استفاده از کاتالوگ‌های آنها و انتخاب یک نمونه مناسب برای شرایط پیشنهادی	بالاتر از حد انتظار	درک متون انگلیسی و اصطلاحات تخصصی در		
۲	درک متون تخصصی انگلیسی و توانایی استخراج موارد ایمنی، زیست محیطی و مشخصات فنی ماشین‌های کشاورزی و ویژگی‌های اجزای آنها از کتابچه راهنما یا سایت اینترنتی شرکت سازنده - مقایسه مشخصات فنی انواع یک ماشین با استفاده از کاتالوگ‌های آنها	در حد انتظار	حوزه ماشین‌های کشاورزی به‌منظور استفاده از کتابچه راهنما، کاتالوگ، نرم‌افزار و یا صفحات تخصصی در اینترنت	کسب اطلاعات فنی	کسب اطلاعات فنی
۱	عدم توانایی در برداشت اطلاعات تخصصی مورد نیاز از متون انگلیسی	پایین‌تر از انتظار			
					نمره مستمر از ۵
					نمره شایستگی پودمان از ۳
					نمره پودمان از ۲۰

منابع و مأخذ:

- ۱- اعظم، فرزاد و همکاران. (۱۳۹۲). نگهداری و تعمیر سیستم‌های هیدرولیک و پنوماتیک. سازمان پژوهش و برنامه‌ریزی آموزشی. دفتر تألیف کتاب‌های درسی فنی و حرفه‌ای و کاردانش.
 - ۲- تاجر محمد قزوینی، حسن. (۱۳۹۱). مبانی هیدرولیک صنعتی. شماره درس ۲۹۹۹. شرکت چاپ و نشر کتاب‌های درسی ایران.
 - ۳- خدام، شاهین. (۱۳۷۷). دینامیک ماشین و مکانیزم‌ها. سازمان تحقیقات، آموزش و ترویج کشاورزی.
 - ۴- حوری جعفری، حامد و همکاران. (۱۳۹۶). تعمیر و نگهداری تجهیزات گرمایشی و سرمایشی. سازمان پژوهش و برنامه‌ریزی آموزشی. دفتر تألیف کتاب‌های درسی فنی و حرفه‌ای و کاردانش.
 - ۵- جاریانی، ابوالقاسم و همکاران. (۱۳۹۴). الکترونیک عمومی ۱. شرکت چاپ و نشر کتاب‌های درسی ایران.
 - ۶- فضلی نژاد، مهدی و همکاران. (۱۳۹۶). نصب و راه اندازی مصنوعات مکترونیک. سازمان پژوهش و برنامه‌ریزی آموزشی. دفتر تألیف کتاب‌های درسی فنی و حرفه‌ای و کاردانش.
 - ۷- ریاضی، احمد و همکاران. اصول الکترونیک، دانشگاه شهید شمس پور.
 - ۸- سرابی، فرشاد. سیستماتیک و دینامیک ماشین. جزوه آموزشی. شرکت مهندسی پتروپلامحور.
 - ۹- صموتی، سید محمود و همکاران. (۱۳۹۴). الکترونیک عمومی ۲. شرکت چاپ و نشر کتاب‌های درسی ایران.
 - ۱۰- کاشفی، محمدرضا و همکاران. (۱۳۷۶). مکانیزم و دینامیک ماشین‌ها. مؤسسه انتشارات علمی. دانشگاه صنعتی شریف.
 - ۱۱- وهاب زاده. راهنمای کاربردی طراحی و ساخت سیستم‌های هیدرولیک. شرکت بنیان تدبیر پارس.
 - ۱۲- همت، عباس. طراحی و شناخت سیستم‌های هیدرولیک. جزوه آموزشی. دانشگاه صنعتی اصفهان.
 - ۱۳- کتابچه راهنمای تراکتورهای ITM، سری ۲۰۰، تراکتورسازی تبریز.
 - ۱۴- کتابچه راهنمای تراکتورهای ITM، سری ۳۰۰، تراکتورسازی تبریز.
- 15- Vicker,s Industrial Hyraulic Manual, Third Edition, 1993, Deer and company, Molin, Illinois.
- 16- S, R Majumear. Oil Hydraulic system Principles and Maintenance, Mcgraw – Hill Pub. Fifth Reprnt 2004.
- 17- Machine tool Design Part 4, By 70 yermakov. Mir Publishers.



هنرآموزان محترم، هنرجویان عزیز و اولیای آنان می‌توانند نظرهای اصلاحی خود را درباره مطالب این کتاب از طریق نامه
برنشانی تهران - صندوق پستی ۴۸۷۴ / ۱۵۸۷۵ - گروه درسی مربوط و یا پیام‌نگار tvoccd@roshd.ir ارسال نمایند.

وب‌گاه: tvoccd.oerp.ir

دکتر تالیف کتاب‌های درسی فنی و حرفه‌ای و کار دانش